

// Complete Selection of High Quality Commercial Doors



## COMMERCIAL DOORS

Exemplary in quality, safety and design

**HÖRMANN**



## CONTENTS

- 6 Unsurpassed Reliability, Energy Efficiency and Safety
- 10 H-720A
- 14 H-425U
- 18 H-324S & H-325S
- 22 H-224P & H-225P
- 26 Hörmann Commercial Product Overview
- 28 Commercial Track Applications
- 30 Hörmann Residential Doors





# Everything you have wanted in a commercial door

We often overlook the importance of a quality built door in any building. Hörmann commercial doors are available in a wide range of materials, sizes and design options. Sophisticated engineering and state-of-the-art manufacturing provide the basis for durable, reliable and long-lasting quality products. We are constantly expanding our knowledge and experience to provide a safe, secure, energy efficient and convenient access to your building. No matter which design suits your needs, you will never compromise on quality and safety with a Hörmann door.





FS 508

ME 310

“A good name must be earned.”

This was the philosophy August Hörmann, founder of the company, believed in when he started manufacturing steel doors in his metalworking shop back in the 1930s. Since then, Hörmann has become one of the world's leading door manufacturers and a global leader in today's building components industry. The family's name has become synonymous to brand quality products covering a wide range of doors in residential and commercial applications. Constant innovation, quality assurance and close proximity to customers are the keys to the company's permanent growth and lasting success. Operated by the third and fourth generation, the grandson and great grandsons of the company's founder, Hörmann currently serves customers in more than 30 countries with a multitude of quality products.



## 1 German Engineered, American Made Quality

The Hörmann range of commercial doors and openers are specially designed and developed to meet the requirements of the North American market without compromising the Hörmann standard for quality and design offering superior protection and safety.





## 2 Uncompromising Safety

At Hörmann your safety always comes first. With our Exclusive FingerGuard™ pinch resistant section joints and components, the danger of trapped fingers is greatly reduced. The joint and hinges provide an excellent seal and prevent finger injuries inside and outside.

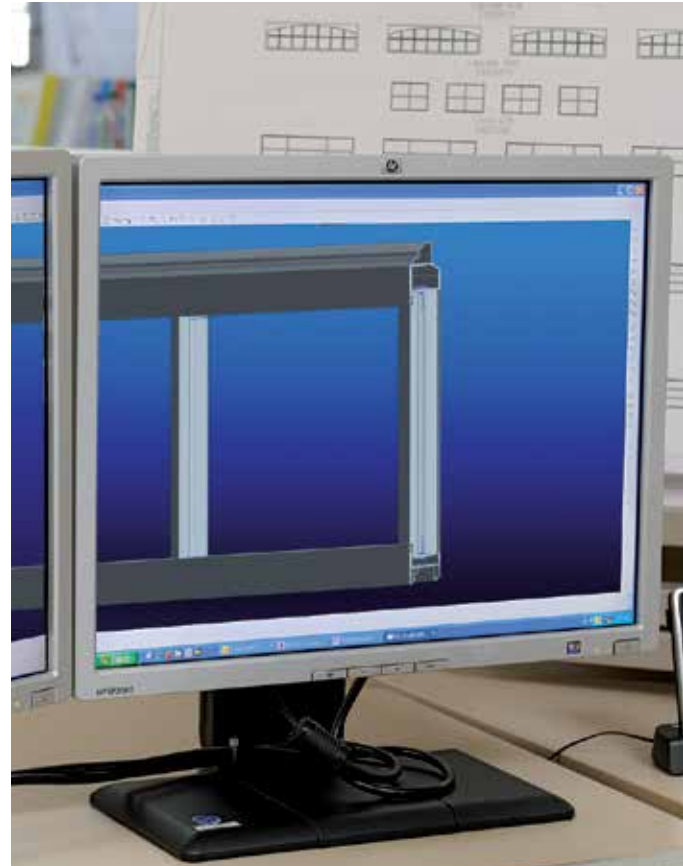

## 3 Highest Standards in Component Quality

Every individual door component is meticulously engineered and tested rigorously. Once they are up to Hörmann's high standards, these components are manufactured with the highest craftsmanship using only top quality materials.



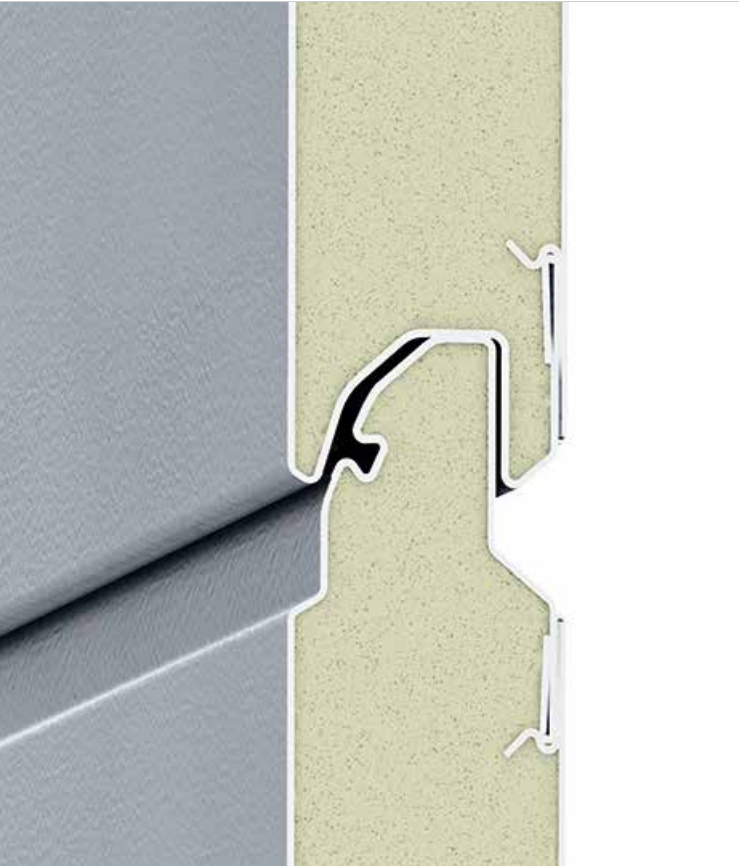

**10 YEARS**  
**LIMITED WARRANTY**

## 4 Superior Energy Efficiency

Hörmann offers a wide choice of insulation to make your door well insulated in harsh climates. Whether polystyrene core or injected polyurethane foam insulation, your home is well protected from outside elements.

## 5 Industry Leading Warranty

All Hörmann commercial door sections are protected with a 10 year limited warranty. With its industry leading warranty, Hörmann stands behind the quality doors that we build.





H-720A

1¾" Glazed Aluminum Sections

## Maximum visibility and natural light

Hörmann H-720A adds a modern look and maximizes the natural light in any building. The 1¾" thick high quality anodized aluminum glazing frames can be fitted with a wide range of glazing or panel filler options to achieve the desired look for your building.







## FEATURE VALUES

- Pinch-resistant section joints interior and exterior
- 15" radius bracket mount track standard (12" radius option in 2" track up to 14' high door only)
- Between section weather seal
- Step plate, lift handle & pull rope included
- Fully enclosed aluminum rails
- Standard bottom weather seal
- Inside slide lock included



\*Ask your dealer for details



H-720A  
 1¾" Glazed Aluminum Sections

**PANEL OPTIONS**



Clear Anodized  
 Aluminum



Insulated  
 Aluminum Laminate



Polyurethane Insulated  
 Steel Section



Smooth Anodized  
 Insulated or non-insulated available



Painted (Galaxy Paint System)  
 Smooth or stucco panels only



Stucco Anodized

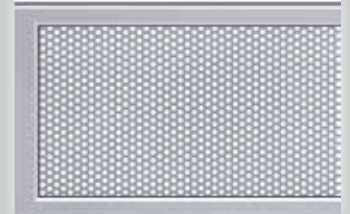

Perforated

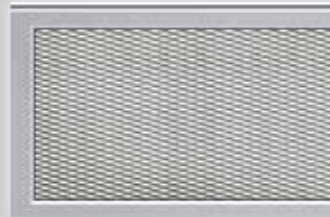

Expanded Mesh

**GLAZING OPTIONS**



Clear (Standard) / Polycarbonate



Frosted



Smoked



Brown Tinted



Tundra



Molded Multi-Tubing Pane



**FingerGuard™  
Pinch Resistant**



H-720A comes standard with the FingerGuard™ section joint and hinges provide air-tight seal and prevent finger injuries inside and outside.

**Between Section &  
Glazing Seals**



Factory installed between section weather seal and glazing seal offer maximum protection from the outside elements while further enhancing the insulation properties of a door.

**COLOR OPTIONS**



Clear Anodized (Standard)



White\*

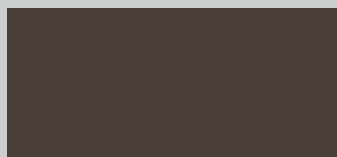

Dark Bronze\*

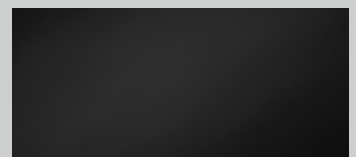

Black\*

\*Just a few of unlimited color options available using Hörmann's Galaxy Paint System

**POWDER COATED HARDWARE OPTIONS**

- Available Colors: White, Bronze and Black
- Section and Mounting Hardware
- Jamb Brackets, Flags, End and Center Bearing Supports



**TOP WEATHER SEAL OPTION**



H-425U

Polyurethane insulated 1 $\frac{3}{4}$ " Steel Sections

## The ultimate choice in efficiency, safety and quality

Hörmann H-425U offers 1 $\frac{3}{4}$ " thick two sided steel sections and 100% CFC-free polyurethane foam core insulation for maximum protection against the elements. (R-value 16.1) Manufactured to the highest quality standards in the industry, all H-425U doors come with Hörmann exclusive FingerGuard™ pinch resistant section joints.





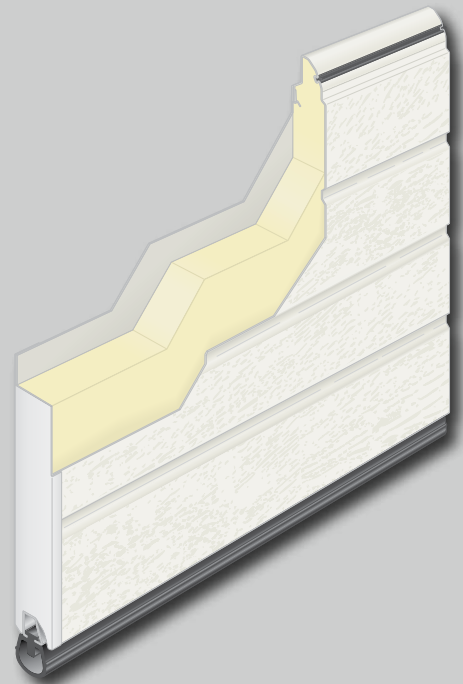

## FEATURE VALUES

- 1 $\frac{3}{4}$ " thick galvanized, finish painted and laminated 25 ga. steel sections are durable for industrial use
- Heavy duty 3-layer sandwich construction injected with 100% CFC & HCFC polyurethane foam that fills all cavities and bonds to the front and back steel panels for superior insulation properties, strength and construction
- Safe pinch-resistant section joints interior and exterior reduce the risk of accidents and injuries during opening and closing
- Energy efficient 16.1 R-Value for maximum energy cost savings
- Between section weather seal keeps out rain, dust and insects



\*Ask your dealer for details

## PANEL DESIGNS



Ribbed (Standard)



Flush (Optional)

## WINDOW OPTIONS



Window 24" X 8"



Window 24" X 12"

Insulated glass is standard on all H-425U doors.



Aluminum Full View Windows

Clear anodized aluminum frame with clear single pane tempered glass is standard. The number of windows available depends on door width. Each section is equipped with pre-punched painted end caps, aluminum glass retainers, and the same between section seal as the steel sections.

## SURFACE FINISH

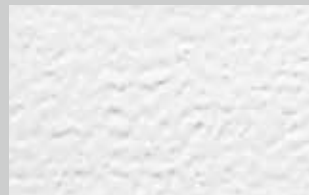

Stucco (Ribbed)

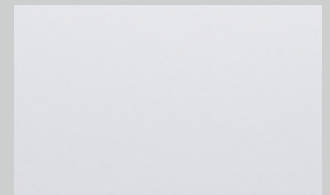

Smooth (Flush)

## CUT AND CAP OPTION



Ribbed doors standard in 6" increments of height. 3" increments, e.g. 10'3" or 10'9" require "Cut and Cap" solution. The top section is cut down, reinforced at operator attachment points, and capped with a profile that has an integrated header seal.



### Energy Efficiency and Superior Design

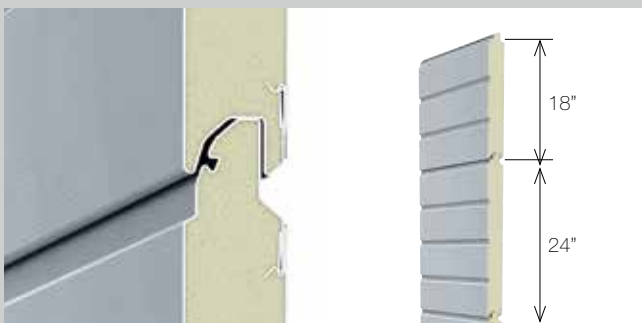

Environmentally friendly polyurethane foam core is injected between 25 gauge galvanized steel sheets front and back. This provides maximum insulation for substantial energy savings and ultimate panel stability for extremely quiet door operation. H-425U's standard section heights, 18" and 24" allow evenly placed ribs throughout the entire door height. The section joints appear seamless and offer a clean and balanced look to any building's exterior.

### TOP WEATHER SEAL OPTION



### COLOR OPTIONS



Hörmann's exclusive Galaxy Paint System is available to further customize your new H-425U door with 28 semi-custom colors or unlimited color matching capabilities.

### LOCK OPTIONS





## Best value in safety, durability and efficiency

Two steel thicknesses are available:  
**25 gauge (.019" min)** for H-325S or  
**24 gauge (.022" min)** for H-324S.

Both series offer an R-value of 8.9, 3-layer bonded construction with a hot-dipped galvanized finished steel front and back, enclosing a HCFC-free polystyrene core. No matter which door suits your needs best, all H-325S and H-324S doors are manufactured to the highest quality standards and come with FingerGuard™ pinch-resistant section joints as standard.





## FEATURE VALUES

- Galvanized & primed 25 ga. (H-325S) and 24 ga. (H-324S) steel with top coat finish for years of protection against the elements
- 3-layer sandwich construction with polystyrene core bonded to steel front and back increases energy savings and provides a very smooth and quiet operation
- Safe pinch-resistant section joints interior and exterior reduce the risk of accidents and injuries during opening and closing
- R-Value of 8.9 reduces energy costs
- White painted end caps for a clean finish interior
- Factory installed between section and side seals add extra layer of protection against unwanted elements
- Bottom weather seal with aluminum retainer for years of rust-free operation

**10 YEARS**  
**LIMITED WARRANTY**

\*Ask your dealer for details

**PANEL DESIGNS**



Microgroove



Flush

**WINDOW OPTIONS**



Window 24" X 6"



Window 24" X 12"

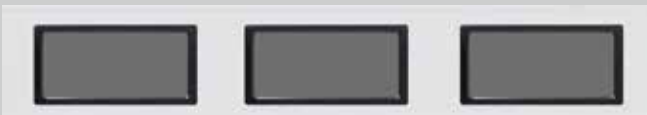

Window 34" X 16"

Single pane is standard for non-insulated doors. Insulated glass is standard for both vinyl back insulated and sandwich doors.

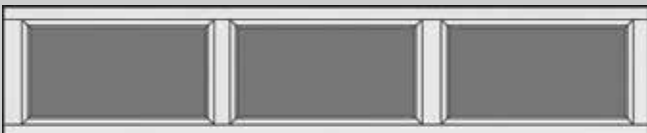

Opti-View Windows\*

Hörmann Opti-View is the optimum choice for commercial applications where maximum light and visibility is required. The Opti-View window design offers similar features as other full view window designs.

Clear single pane tempered glass is standard for both insulated and non-insulated doors. The number of windows available per section depends on the door width.

\*Not available for raised panel design



Raised Panel

**SURFACE FINISH**



Stucco (Microgroove & Flush)

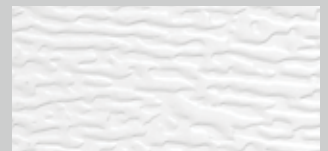

Woodgrain (Raised panel)

**ROLLERHOLDER REINFORCEMENT**



The rollerholder reinforcement assembly meets section 9.2.1 Dead Loads for Commercial Door Sections in ANSI-DASMA 102 and is equivalent to double end stile when required per CSI specifications.





### Maximum Protection and Energy Savings



The polystyrene insulation fills the top of the door channel for enhanced energy efficiency and sound-dampening qualities. With 2" thick sections, both series gives you an R value of 8.9. Factory installed between section weather seals and side seals offer maximum protection against the outside elements while further enhancing the insulation properties of a door.

### BRIDGE & OPERATOR BRACKET OPTIONS



### COLOR OPTIONS

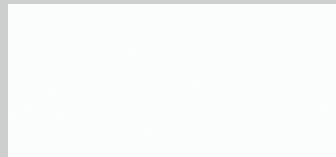

White

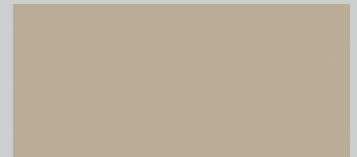

Sandstone

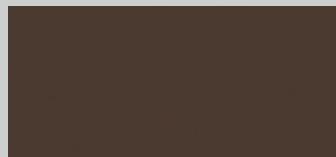

Brown

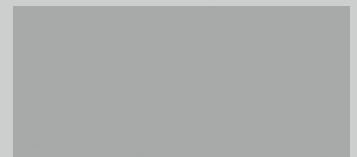

Grey\*

\*Not available for H-324S Series

### LOCK OPTIONS



## Economical choice for safety and quality

Two steel thicknesses are available:  
**25 gauge (.019" min)** for H-225P or  
**24 gauge (.022" min)** for H-224P.

Both doors are hot-dipped and galvanized for maximum durability. No matter which door suits your needs best, all H-225P and H-224P doors are manufactured to the highest quality standards and come with FingerGuard™ pinch-resistant section joints as standard.





## FEATURE VALUES

- 2" thick galvanized and finish painted 25 ga.(H-225P) or 24 ga.(H-224P) steel for superior strength and durability
- Safe pinch-resistant section joints interior and exterior reduce the risk of accidents and injuries during opening and closing
- Optional CFC Free polystyrene insulation with vinyl backcover (R-Value of 7.4) provides clean finished door with added energy saving benefits
- Factory installed between section and side seals add extra layer of protection against unwanted elements
- Bonded galvanized fully boxed center stiles and end stiles will not warp, twist or deform like other similar competitor components
- Bottom weather seal with aluminum retainer for years of rust-free operation



\*Ask your dealer for details



**PANEL DESIGNS**



Ribbed



Flush\*

\*Not available for H-225P

**WINDOW OPTIONS**



Window 24" X 6"



Window 24" X 12"

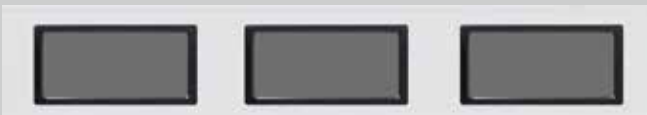

Window 34" X 16"

Single pane is standard for non-insulated doors. Insulated glass is standard for vinyl back insulated doors.



Raised Panel

**SURFACE FINISH**



Stucco (Ribbed & Flush)

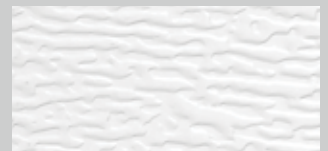

Woodgrain (Raised panel)

**ROLLERHOLDER REINFORCEMENT**

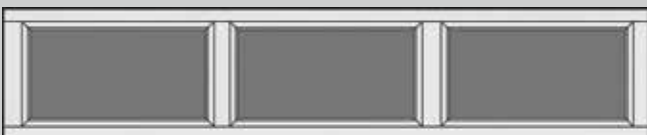

Opti-View Windows\*

Hörmann Opti-View is the optimum choice for commercial applications where maximum light and visibility is required. The Opti-View window design offers similar features as other full view window designs.

Clear single pane tempered glass is standard for both insulated and non-insulated doors. The number of windows available per section depends on the door width.

\*Not available for raised panel design



The rollerholder reinforcement assembly meets section 9.2.1 Dead Loads for Commercial Door Sections in ANSI-DASMA 102 and is equivalent to double end stile when required per CSI specifications.



### Maximum Strength and Increased Energy Savings

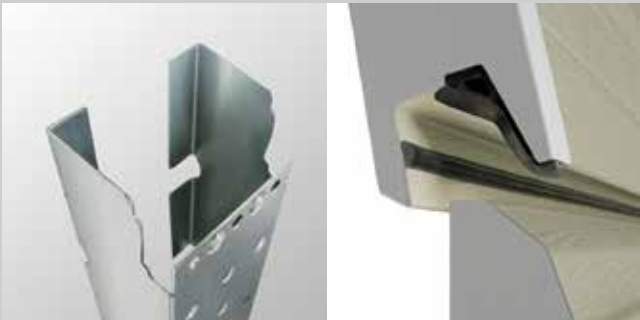

The H-224P & H-225P features unique construction with full box stile (vertical supports) for both maximum strength and quiet operation. Factory installed between section weather seals and side seals offer maximum protection against the outside elements while further enhancing the door's insulating properties for doors with optional insulation.

### BRIDGE & OPERATOR BRACKET OPTIONS



### COLOR OPTIONS



White

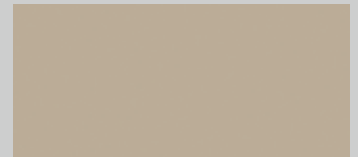

Sandstone

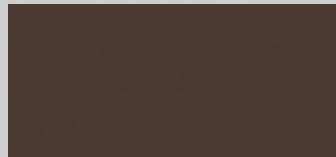

Brown

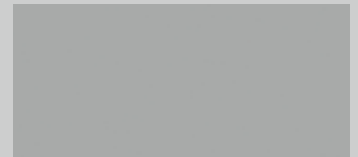

Grey (Optional)\*

\*Not available for H-224P Series

### LOCK OPTIONS



# HÖRMANN COMMERCIAL PRODUCT OVERVIEW

● = Standard  
○ = Optional

		Non-Insulated	
		H-225P	H-224P
<b>Exterior steel thickness</b>		25 ga.	24 ga.
<b>Backcover steel thickness</b>		–	–
<b>Insulation with vinyl backcover</b>		○	○
<b>Section thickness</b>		2"	2"
<b>R-Value</b>		7.4 with Optional Insulation	
<b>Section design</b>	Ribbed	●	●
	Microgroove	–	–
	Flush	–	●
	Traditional Raised Panel	●	●
<b>Section Height</b>	18"	–	–
	21"	●	●
	24"	●	●
<b>Bottom weather seal</b>		●	●
<b>Retainer</b>		Aluminum	Aluminum
<b>External texture</b>	Ribbed	Stucco	Stucco
	Flush	–	Stucco
	Raised Panel	Woodgrain	Woodgrain
<b>Backcover texture</b>	Stucco emboss	–	–
<b>Between section weather seal</b>		●	●
<b>Safety feature</b>	Pinch resistant sections	●	●
<b>End &amp; center stiles</b>	Painted	–	–
	Galvanized	●	●
	Aluminum	–	–
<b>Tracks</b>	2" bracket mount	●	●
	2" or 3" angle mount	○	○
	2" or 3" tapered angle mount	○	○
	15" Radius	●	●
	12" Radius up to 14' high	○	○
	20" Radius up to 10' high	○	○
	Low headroom	○	○
	High-lift	○	○
Full vertical	○	○	
<b>Colors</b>	White	●	●
	Sandstone	●	●
	Brown	●	●
	Grey	○	–
<b>Window options</b>	24" X 6"	○	○
	24" X 8"	–	–
	24" X 12"	○	○
	34" X 16"	–	–
	Opti-View	○	○
	Aluminum Full View	–	–
<b>Glass options</b>	Single pane	○	○
	Insulated	–	–
<b>Warranty</b>	Sections	10 yrs.	10 yrs.
	Hardware	1 yr.	1 yr.
<b>Step plate, lift handle &amp; pull rope</b>		●	●
<b>Locks</b>	Slide lock	●	●
	Keyed	○	○



	Insulated (Polystyrene)		insulated (Polyurethane)	Aluminum
	H-325S	H-324S	H-425U	H-720A
	25 ga.	24 ga.	25 ga.	-
	27 ga.	27 ga.	25 ga.	-
	-	-	-	-
	2"	2"	1¾"	1¾"
	8.9	8.9	16.1	Glass Dependent
	-	-	●	Various Glazed and Aluminum Section Designs
	●	●	-	
	●	●	○	
	●	●	-	Various Section Heights Available
	-	-	●	
	●	●	○	
	●	●	●	
	●	●	●	●
	Aluminum	Aluminum	Aluminum	Aluminum
	Stucco	Stucco	Stucco	Clear Anodized Aluminum
	Stucco	Stucco	Smooth	
	Woodgrain	Woodgrain	-	
	●	●	●	
	●	●	●	●
	●	●	●	●
	-	-	-	-
	-	-	-	●
	●	●	●	●
	○	○	○	○
	○	○	○	○
	●	●	●	●
	○	○	○	-
	○	○	○	○
	○	○	○	○
	○	○	○	○
	○	○	○	○
	●	●	●	Clear anodized aluminum standard
	●	●	-	
	●	●	-	
	●	-	-	Other colors available via Galaxy Paint System
	○	○	-	
	-	-	○	Window insert & designs custom manufactured
	○	○	○	
	○	○	-	
	○	○	-	
	-	-	○	
	-	-	-	○
	○	○	○	○
	10 yrs.	10 yrs.	10 yrs.	10 yrs.
	1 yr.	1 yr.	1 yr.	1 yr.
	●	●	●	●
	●	●	●	●
	○	○	○	-

COMMERCIAL TRACK APPLICATIONS



## Track Applications that Fit Perfectly to Any Building

Whichever door type you have selected for your building: At Hörmann, you will find the best track application to match your door. Depending on the building architecture and requirement, you can choose between the perfect track application.

### Standard Lift

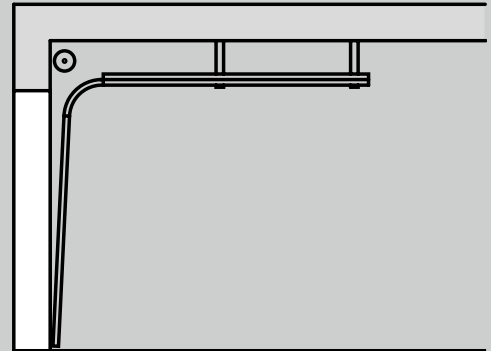

### Low Head Room - Dual Track

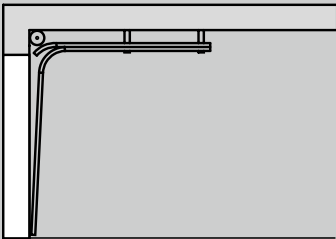

Front Mount

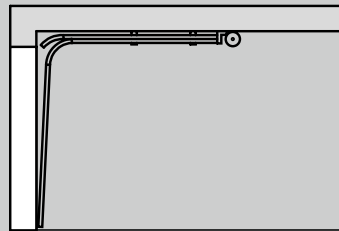

Rear Mount

### High Lift

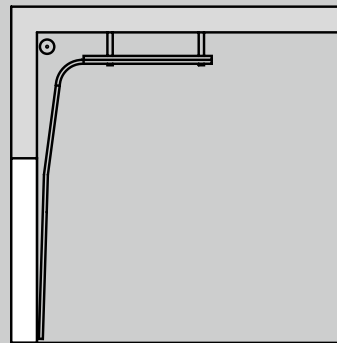

Break-Away (Standard)

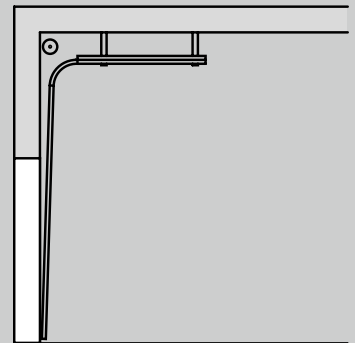

Single Incline

### Vertical Lift

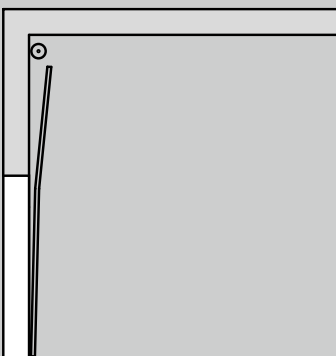

Break-Away (Standard)

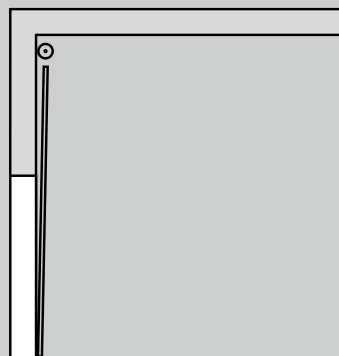

Single Incline

### Roof Pitch

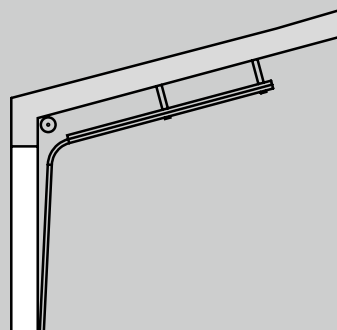

Standard Lift

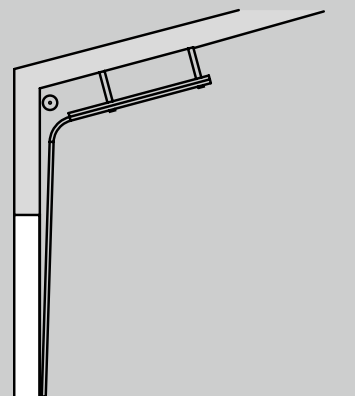

High Lift



## A Complete Selection of High Quality Residential Doors

Hörmann residential doors offer a wide range of styles, colors, sizes and design options. Sophisticated engineering and state-of-the-art manufacturing provide the basis for durable, reliable and long-lasting quality products.



► Orion 3210 - Cottage Design with Sunrise Windows



▲ Titan 4250 - Traditional Design with Cross Windows







◀ Phoenix 5200  
Scottsdale Design with Arch Windows



Everything you've always wanted in a garage door, and more.

**HÖRMANN**

**Our promise to you.**

As one of the world's leading manufacturers of doors we're committed to providing the best quality, value, and selection. Whether residential or commercial; whether steel, aluminum, wood, or high density polyethylene;

whether traditional or contemporary; we have the door you're looking for. Each Hörmann door gives you the perfect array of benefits and options with the drive to match.



Hörmann LLC, Montgomery, IL  
Headquarters and Manufacturing Plant



*Environmental commitment has been part of our corporate culture for decades. From our manufacturing processes to the products we make.*

*In everything we do we strive to minimize energy and use of resources through efficient processes, long-lasting quality and innovative engineering.*

**AVAILABLE FROM:**

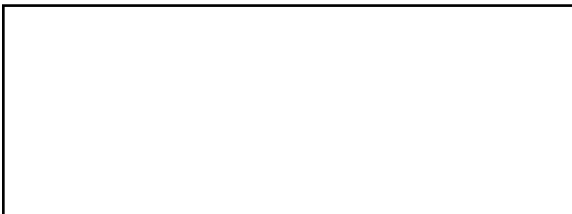

**Call us ► 1 877 OK HORMANN (1-877-654-6762)**

Hörmann LLC, 5050 Baseline Road, Montgomery, Illinois 60538  
Phone: 630-859-3000 Fax: 630-859-8122  
Email: [info@hormann.us](mailto:info@hormann.us) [www.hormann.us](http://www.hormann.us)



Printed in USA.  
©Hörmann LLC  
H/E/PPK/#5000 (VERSION 1, PRINT 02.17)